

P000

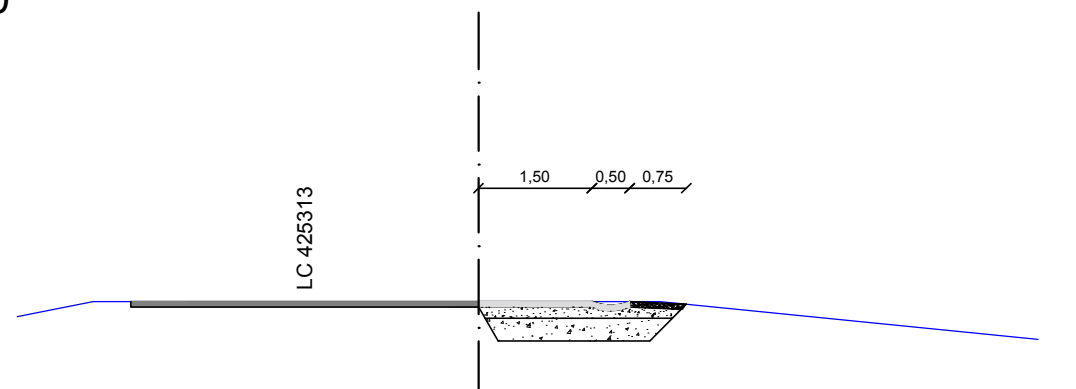

P050

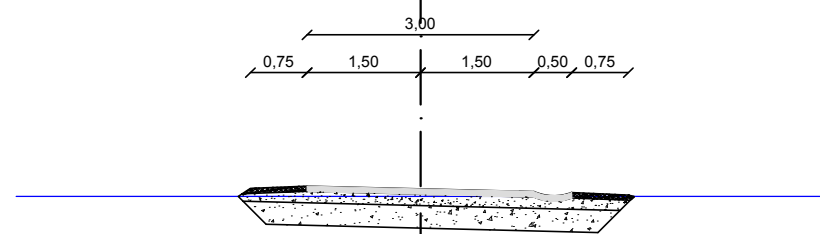

P100

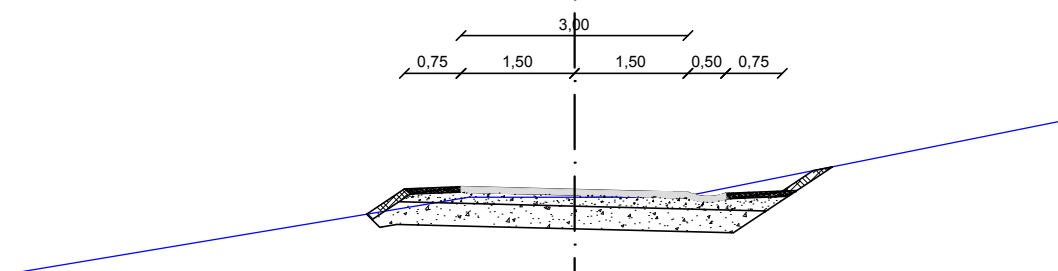

P150

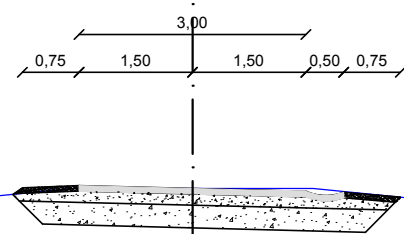

P200

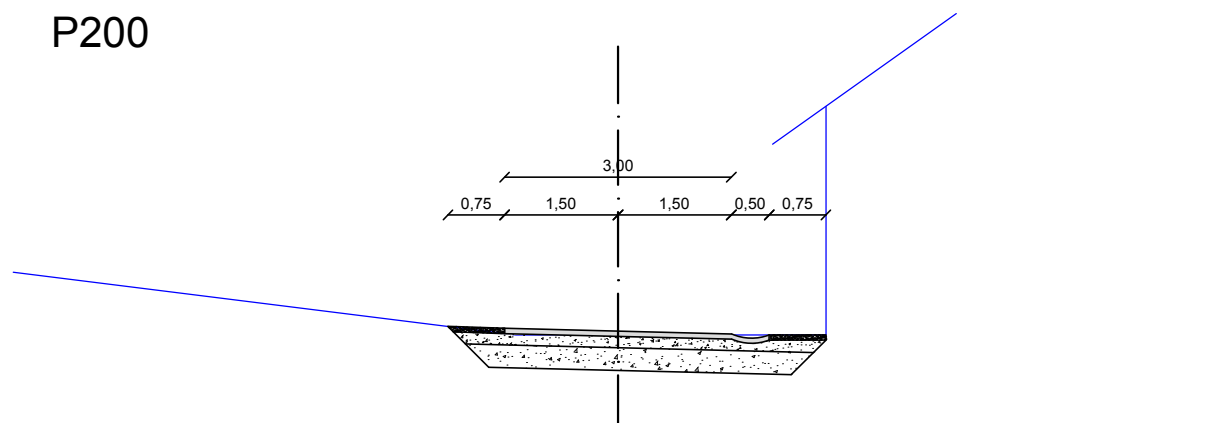

P250

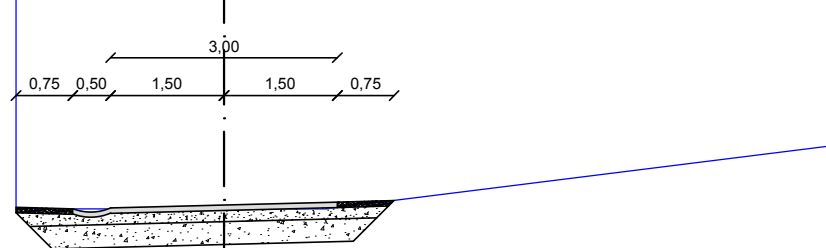

P280

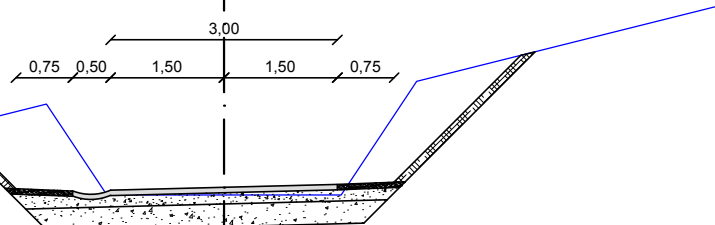

P296

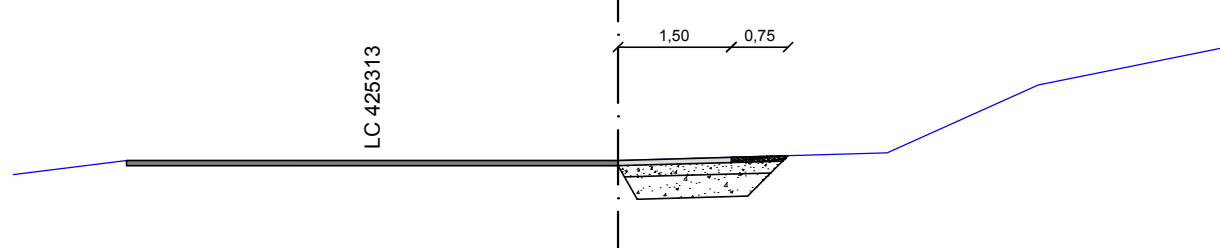

GRADBENI NAČRT  
SKICA PREČNIH PROFILOV

M 1:100

investitor:	OBČINA LITJA Jerebova ulica 14 1270 Litija	 projektiranje, cenitve nepremičnin inženiring v gradbeništvu nadzor, strokovno vodenje pri graditvi objektov Ulica Mire Pregljeve 4 1270 Litija tel: 01/8980-150 fax: 01/8980-155 email: info@pino.si splet: www.pino.si
objekt:	MODERNIZACIJA JAVNE POTI JP 710461 - RADGONICA (L=296 m)	
načrt:	GRADBENI NAČRT SKICA PREČNIH PROFILOV	vodja projekta: JOŽE POGLAJEN, univ.dipl.inž.grad. odgovorni projektant: JOŽE POGLAJEN, univ.dipl.inž.grad. št. odg. projektanta: IZS G-1091 projektant: MIHA TOMAŽIČ, dipl.inž.grad. št. proj.: 26/17 datum: maj 2017 merilo: 1:100 št. lista: 3
faza:	IZN	